

M3 MOBILE



















Mobile Computer

SM30

Accessories Guide



SM30 ACC. MAP

Cradle	Power Supply	Pocket	Boot	Battery	ETC
	 <p>Fast charging only cradle SMXX-PWSP-CXX</p>	 <p>Pocket cradle compatible with SM2X 2-slot cradle SM3X-POCK-C00</p>	 <p>Rubber boot SM30-BOOT-01</p>	 <p>Battery(5,000mAh) SM30-BATT S50</p>	 <p>Hand Strap (-S01/10/50) SM30-STRP-S01/10/50</p>
<p>2 SLOT CRADLE - DC Jack</p>  <p>SM30-2CRD-C00</p>	 <p>SM30-PWSP-2XX</p>	<p>Vehicle Cradle</p>		 <p>Battery(7,000mAh) SM30-BATT E70</p>	 <p>Bullet proof Screen Protector SM30-SCPR</p>
<p>2 SLOT CRADLE - USB C Type</p>  <p>SM3X-2CRD-C00</p>	 <p>Fast charging only cradle SMXX-PWSP-CXX</p>	 <p>Vehicle Cradle Coming Soon</p>	<p>Trigger</p>  <p>Trigger Handle without Boot SM30-TRIG-S00</p>	 <p>Wireless Charging Battery Coming Soon</p>	
<p>8 SLOT CRADLE</p>  <p>SM3X-8CRD-C00</p>	 <p>SMXX-PWSP-8XX</p>		 <p>Trigger Handle with Boot SM30-TRIG-B00 Coming Soon</p>		
Battery Charger					
<p>4 SLOT</p>  <p>SM30-04BC-C00</p>	 <p>SM30-PWSP-4XX</p>				

Cradle / Charging

2-Slot charging only cradle

SM30-2CRD-C00



I/O DC



Input 5VDC / 5A



Dimension 112.5 x 156 x 71mm



Weight 317g

Compatible

Inclined angle

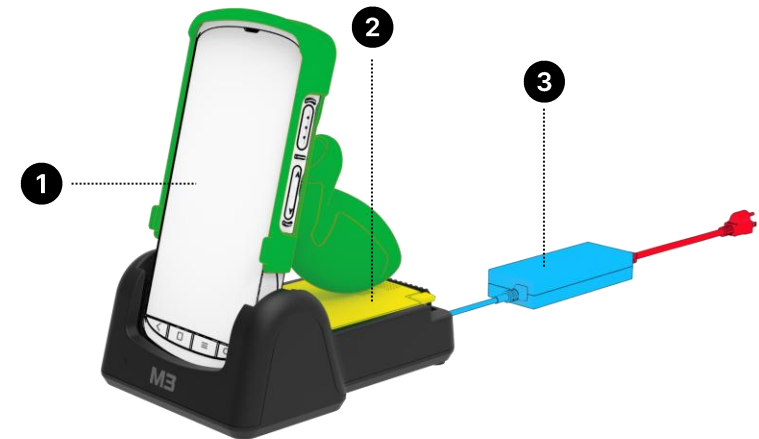

① SM30

SM300E-U2CFSS-HF / SM300E-UFCFSS-HF /
SM305E-U2CFSS-HF / SM305E-UFCFSS-HF

② Battery

SM30-BATT-E50/E70, Wireless Charging Battery

③ Power Supply

SM30-PWSP-2XX

Cradle / Charging

2-Slot Fast charging only cradle

SM3X-2CRD-C00

The SM30 Fast Charging 2-slot/8-slot cradle is **compatible with SM24/25 devices, Battery**. However, for compatibility with SM24/25, a pocket cradle (SKU: SM2X-POCK-C00) must be purchased separately and installed.

Compatible

Right angle

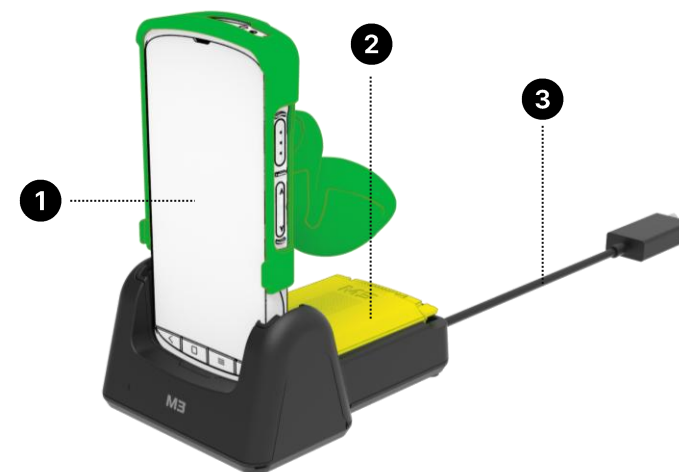

	I/O	USB C Type
	Input	9VDC / 3A
	Dimension	112.5 x 156 x 71mm
	Weight	317g

- 1 SM30** SM300E-U2CFSS-HF / SM300E-UFCFSS-HF / SM305E-U2CFSS-HF / SM305E-UFCFSS-HF
- 2 Battery** SM30-BATT-E50/E70, Wireless Charging Battery
- 3 Power Supply** SMXX-PWSP-CXX

Cradle / Charging

8-Slot charging only cradle

SM3X-8CRD-C00



I/O

DIN



Input

12VDC / 10A



Dimension

449 x 156 x 74.5mm



Weight

890g

The SM30 Fast Charging 2-slot/8-slot cradle is **compatible with SM24/25 devices, Battery**. However, for compatibility with SM24/25, a pocket cradle (SKU: SM2X-POCK-C00) must be purchased separately and installed.

Compatible

Right angle

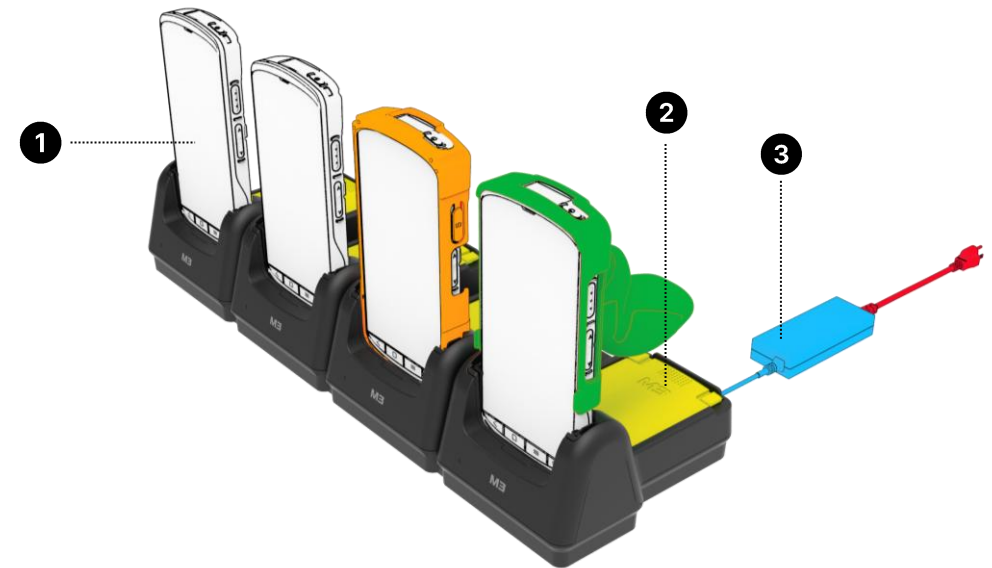

❶ **SM30**

SM300E-U2CFSS-HF / SM300E-UFCFSS-HF /
SM305E-U2CFSS-HF / SM305E-UFCFSS-HF

❷ **Battery**

SM30-BATT-E50/E70, Wireless Charging Battery

❸ **Power Supply**

SMXX-PWSP-8XX

SM30 Cradle Configuration



1/8 Slot Cradle

SM3X-2CRD-C00
SM30-8CRD-C00



Base Cradle

Depending on the installed pocket cradle, the corresponding device can be docked and charged.



SM30 Pocket 1

- Pocket for booted devices



SM30 Pocket 2

- Pocket for non-booted devices



SM24/25
Pocket 1
Pocket for
booted devices

SM24/25
Pocket 2
Pocket for
non-booted
devices

SM24/25 Pock Cradle (SM2X-POCK-C00)

Installing the SM24/25 pocket cradle on the base cradle enables docking and charging of SM24/25 devices.

* Future devices will also be compatible with SM30/SM24/SM25 cradles through pocket cradle replacement.

! For 1/8-slot cradle orders, Pocket 1 is securely screw-mounted to the cradle base prior to shipment, and Pocket 2 is also provided in an assembled state.

! The cradle configurations described on this page apply to the SM3X-2CRD-C00 and SM30-8CRD-C00, which are compatible with SM24/25. The SM30-2CRD-C00 has a different structure and is not compatible with SM24/25.

Charger / Charging

4-Slot Battery Charger

SM30-04BC-C00

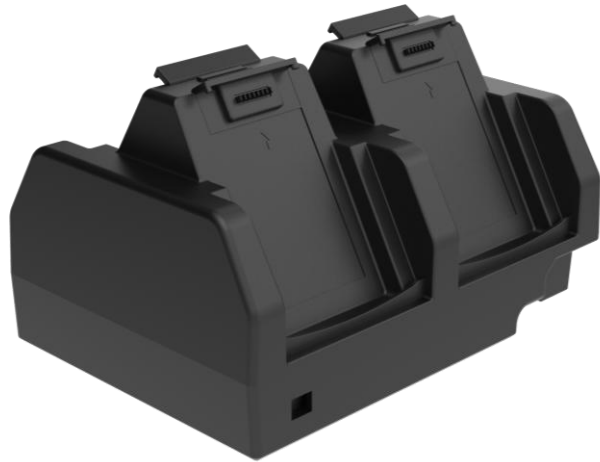

I/O

DC



Input

12VDC / 3A



Dimension

112.5 x 156 x 71mm

Compatible



SM30

SM300E-U2CFSS-HF
SM300E-UFCFSS-HF
SM305E-U2CFSS-HF
SM305E-UFCFSS-HF



SM30 Battery

(SM30-BATT-S50/E70,
Wireless Charging Battery)



Power Supply

(SM30-PWSP-4XX)

Power Supply / Charging

PDA Adaptor Power supply

SMXX-PWSP-CXX

Fast Charging



Input 100~240VAC



Output 9VDC / 3A

Compatible



SM30

SM300E-U2CFSS-HF
SM300E-UFCFSS-HF
SM305E-U2CFSS-HF
SM305E-UFCFSS-HF



2 Slot Cradle
(SM3X-2CRD-C00)

Depending on the type of connector at the end

SMXX-PWSP-CEU/KR/US/UK

Power Supply / Charging

Power Supply for 2 slot cradle

SM30-PWSP-2XX



Compatible



2 Slot Cradle
(SM30-2CRD-C00)

Depending on the type of connector at the end

SM30-PWSP-2EU/UK/US



Input 100~240VAC



Output 5VDC / 5A

Power Supply / Charging

Power Supply for 8 slot cradle

SMXX-PWSP-8XX



Compatible



8 Slot Cradle
(SM3X-8CRD-C00)

Depending on the type of connector at the end

SMXX-PWSP-8EU/KR/US/UK



Input 100~240VAC



Output 12VDC / 10A

Power Supply / Charging

Power Supply for 4-Slot Battery Charger

SM30-PWSP-4XX



Compatible



4 Slot Battery Charger
(SM30-04BC-C00)

Depending on the type of connector at the end

SM30-PWSP-4EU/KR



Input 100~240VAC



Output 12VDC / 3A

Pocket Cradle

2 SLOT Pocket Cradle with SX2X 2-slot cradle

SM3X-POCK-C00



Dimension 90 x 50 x 20mm



Weight 30g

Compatible

The SM3X-POCK-C00 pocket cradle offers compatibility with **SM24/25 cradles**, with plans to extend support to upcoming SM/SL series cradle models.

How to use the SM30 cradle with SM24/25 and future models

This page describes SM3X-2CRD-C00 and SM30-8CRD-C00.

The SM30-2CRD-C00 cradle uses one pocket: non-booted devices charge and dock with the pocket attached, while booted devices do so with it removed.

1 Removal of Pocket 2 Cradle

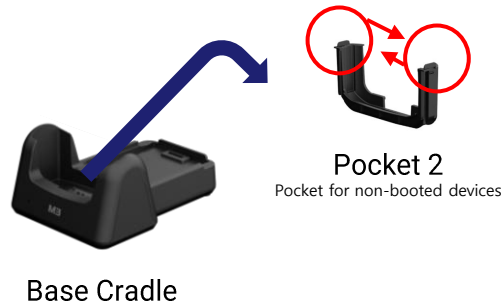

Hold both ends of the pocket marked with red circles, press inward, and remove the Pocket 2 cradle.

2 Removal of Pocket 1 Cradle

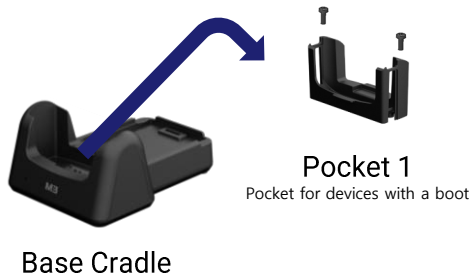

Remove the screw-mounted Pocket 1 cradle from the base cradle using a screwdriver.

3 Installation of the SM24/25 pocket cradle

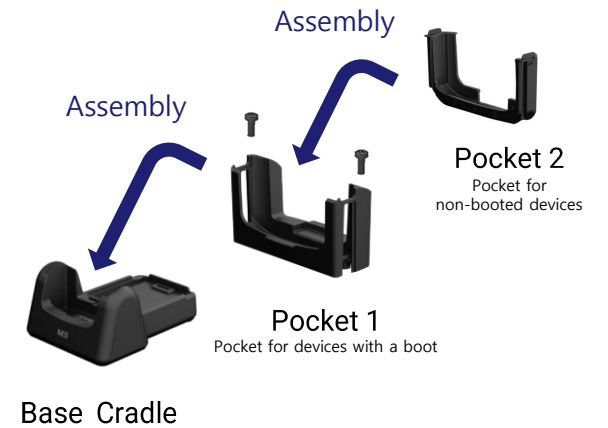

To dock and charge SM24/25 devices, install the SM2X-POCK-C00 cradle on the base cradle with the SM30 pocket cradle removed.

Step 1.

Secure Pocket 1 to the base cradle using screws.

Step 2. Install or remove Pocket 2 depending on whether the device has a boot attached.

(With boot: install Pocket 2 /

Without boot: remove Pocket 2)

* Future devices will also be designed to be compatible with the cradle using the same method.

BOOT

Rubber boot SM30

SM30-BOOT-01

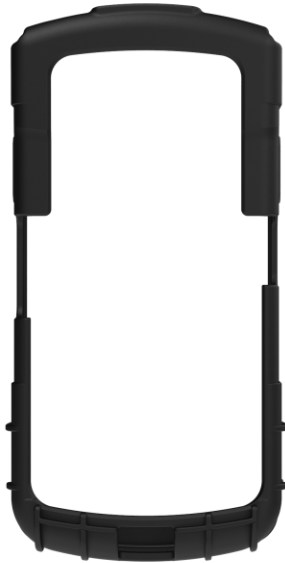

Dimension 172.5 x 87 x 30.8mm



Weight 120g

Compatible



SM30

SM300E-U2CFSS-HF
SM300E-UFCFSS-HF
SM305E-U2CFSS-HF
SM305E-UFCFSS-HF

Guidelines for Using the Cradle While the Device is Equipped with Boots

This page describes SM3X-2CRD-C00 and SM30-8CRD-C00.
The SM30-2CRD-C00 cradle uses one pocket: non-booted devices charge and dock with the pocket attached, while booted devices do so with it removed.

#1 Cradle Charging Guide for Devices with Boots Attached



! When charging the device with the boot (protective cover) attached, please remove Pocket 2 from the cradle first.

Guidelines for Using the Cradle While the Device is Equipped with Boots

This page describes SM3X-2CRD-C00 and SM30-8CRD-C00.
The SM30-2CRD-C00 cradle uses one pocket: non-booted devices charge and dock with the pocket attached, while booted devices do so with it removed.

#2 Cradle Charging Guide Without Boots Attached



- ! When the boot (protective cover) is not attached, charge the device with Pocket 2 assembled to Pocket 1 and the main cradle.
>The product is provided fully assembled and ready for immediate use.

Trigger

Trigger Handle for SM30 without Boot

SM30-TRIG-S00



Compatible



SM30

SM300E-U2CFSS-HF
SM300E-UFCFSS-HF
SM305E-U2CFSS-HF
SM305E-UFCFSS-HF



Dimension 85x 138.7 x 165mm



Weight 120g

Trigger

Precautions for Attaching the Device to the Trigger Handle

✗ DON'T



Unable to Mount the Device on the Trigger Handle

Devices with boots attached cannot be mounted on the trigger handle.

✓ DO



Condition for Attaching the Device to the Trigger Handle

The device can only be mounted on the trigger handle after removing the boots.

Trigger

Cradle Charging Instructions with Trigger Handle Attached

The SM30-2CRD-C00 cradle has a single pocket; non-booted devices charge and dock with the pocket attached, while booted devices do so with it removed.

This page describes SM3X-2CRD-C00 and SM30-8CRD-C00. The SM30-2CRD-C00 cradle uses one pocket: non-booted devices charge and dock with the pocket attached, while booted devices do so with it removed.



When charging a trigger handle–mounted device without a protective boot, both of the following pockets must be installed inside the main cradle :

- Pocket 1 (Booted Device)
- Pocket 2 (Non-Booted Device)



*** For 2/8-slot cradle orders, Pocket 1 is securely screw-mounted to the cradle base prior to shipment.

*** The product is provided fully assembled and ready for immediate use.

Trigger

Trigger Handle for SM30 with Boot

SM30-TRIG-B00 Coming Soon



Compatible



SM30

SM300E-U2CFSS-HF
SM300E-UFCFSS-HF
SM305E-U2CFSS-HF
SM305E-UFCFSS-HF



Dimension -



Weight -

Trigger

Precautions for Attaching the Device to the Trigger Handle

✗ DON'T



Unable to Mount the Device on the Trigger Handle

Devices without boots cannot be attached to the trigger handle.

✓ DO



Condition for Attaching the Device to the Trigger Handle

The device can be mounted on the trigger handle after attaching the boots.

Trigger

Cradle Charging Instructions with Trigger Handle Attached

This page describes SM3X-2CRD-C00 and SM30-8CRD-C00.
The SM30-2CRD-C00 cradle uses one pocket: non-booted devices charge and dock
with the pocket attached, while booted devices do so with it removed.



When charging a device mounted on the trigger handle with a protective boot attached, Pocket 1 (secured by screws) should remain in place, while Pocket 2 (removable by hand) must be removed.

Pocket 1: For booted devices

Pocket 2: For non-booted devices





Battery

SM30 Battery



SM30-BATT-S50



	Dimension	6.9 x 8.5 x 1cm
	Weight	93.4g



SM30-BATT-E70



	Dimension	6.9 x 8.5 x 1cm
	Weight	130.8g

Wireless Charging Battery Coming Soon



	Dimension	-
	Weight	-

ETC. / Miscellaneous

ETC.



SM30-STRP-SXX
Hand Strap for SM30
(01/10/50 pcs)



SM30-SCPR
Bullet proof Screen Protector